

CS2165

Spare parts

Ersatzteile

Pièces détachées

Reserve onderdelen

Repuestos

Reservdelar

A CS2165
CHAIN BRAKE & CLUTCH COVER

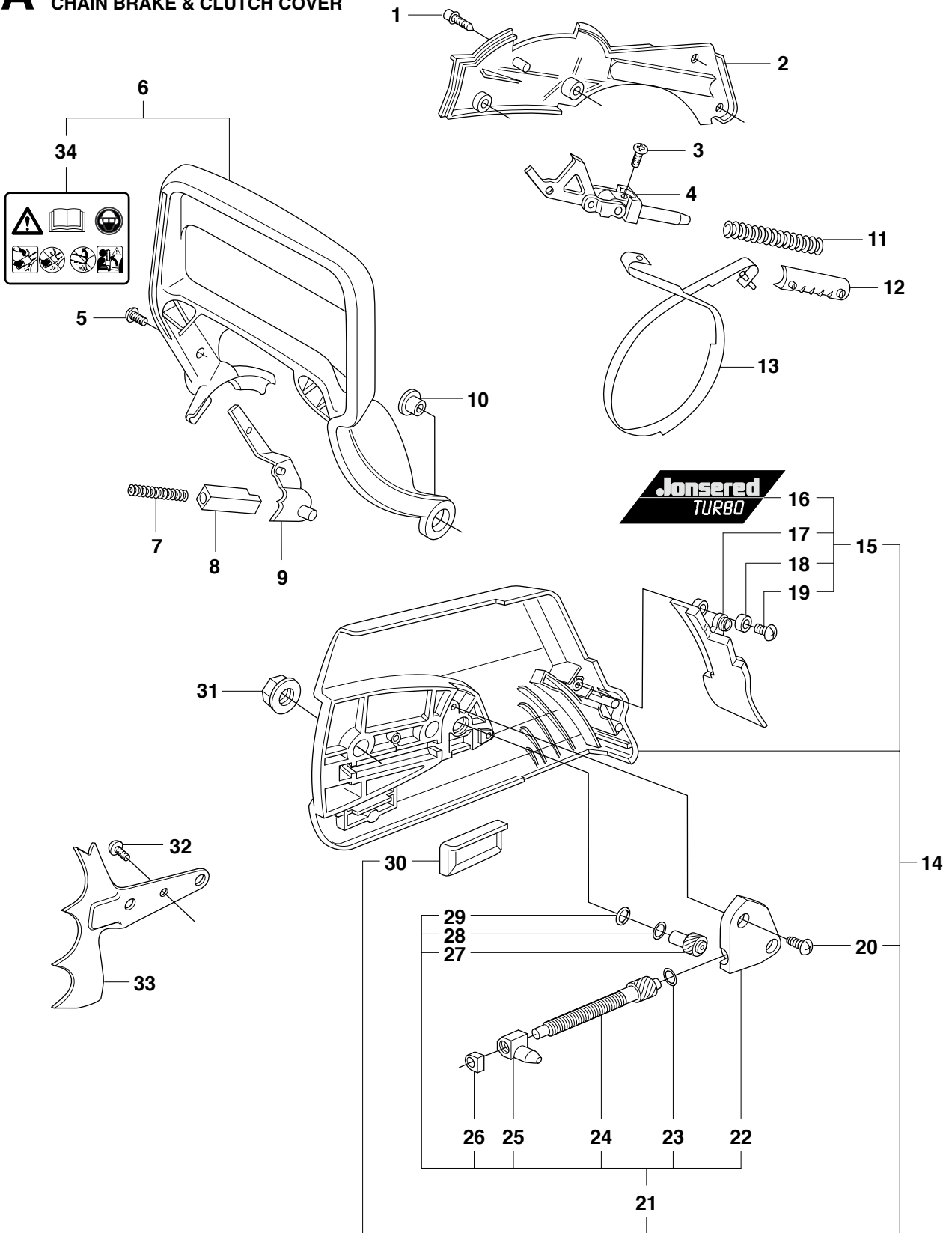

Page A		CS2165		CHAIN BRAKE & CLUTCH COVER	
Position	Article	Quantity	Notes	Kit	
1	503 20 02-12	4			
2	503 75 11-03	1			
3	503 21 28-10	1			
4	501 87 53-03	1			
5	503 20 25-12	1			
6	503 71 93-04	1			
7	503 43 65-01	1			
8	503 83 81-02	1			
9	537 00 87-02	1			
10	503 77 52-01	1			
11	503 70 99-01	1			
12	503 79 27-02	1			
13	503 75 22-02	1			
14	537 07 20-01	1			
15	537 07 20-71	1		14	
16	537 24 43-01	1		14, 15	
17	503 76 29-02	1		14, 15	
18	503 89 70-01	1		14, 15	
19	503 21 28-10	1		14, 15	
20	503 21 28-10	2		14	
21	537 04 41-02	1		14	
22	537 01 68-01	1		14, 21	
23	503 23 00-66	1		14, 21	
24	537 07 95-02	1		14, 21	
25	503 99 83-01	1		14, 21	
26	537 01 74-01	1		14, 21	
27	537 07 94-02	1		14, 21	
28	503 23 00-63	1		14, 21	
29	740 48 07-02	1		14, 21	
30	501 51 72-01	1		14	
31	503 22 00-01	2			
32	503 21 28-10	1			
33	503 71 97-01	1	WRAP		
34	503 98 74-01	1			

B CS2165
CLUTCH & OIL PUMP

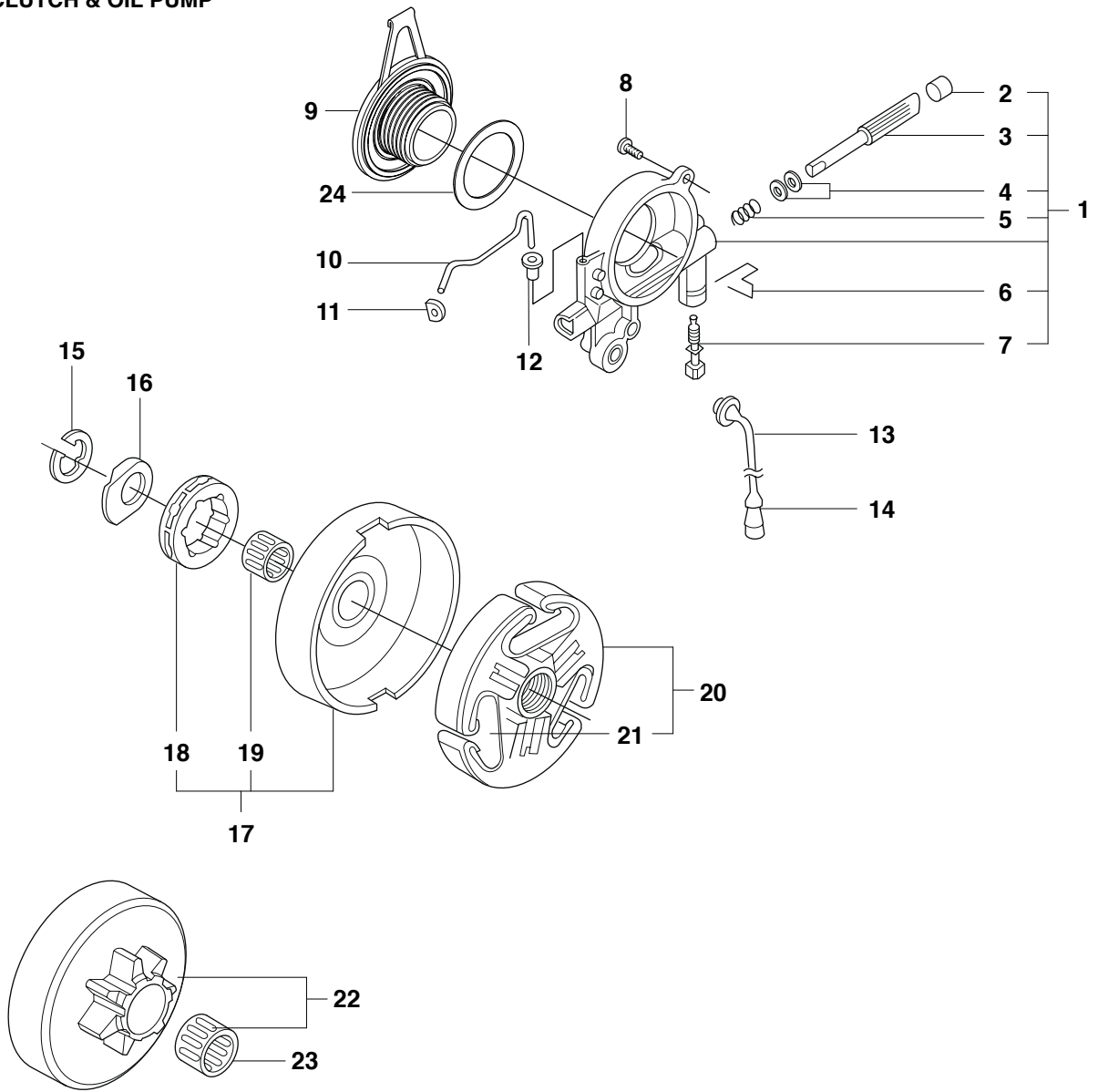

Position	Article	Quantity	Notes	Kit
1	503 52 13-03	1		
2	503 62 49-01	1		1
3	503 52 15-01	1		1
4	503 23 00-04	2		1
5	501 61 58-01	1		1
6	503 81 30-01	1		1
7	503 81 13-01	1		1
8	725 53 29-56	2		
9	537 20 78-05	1		
10	503 77 43-01	1		
11	503 64 47-01	1		
12	504 30 00-26	1		
13	503 42 67-01	1		
14	501 54 41-02	1		
15	503 27 21-01	1		
16	503 75 24-01	1		
17	503 93 24-71	1	3/8"x7T	
17	503 93 24-72	1	3/8"x8T	
18	501 59 80-02	1	3/8"x7T	17
18	505 30 36-61	1	3/8"x8T	17
19	503 43 20-01	1		17
20	503 74 44-01	1		
21	537 36 06-01	3		
22	503 86 17-03	1	3/8"x7T	
23	503 43 20-01	1		
24	503 23 00-59	1		

C CS2165
CYLINDER COVER

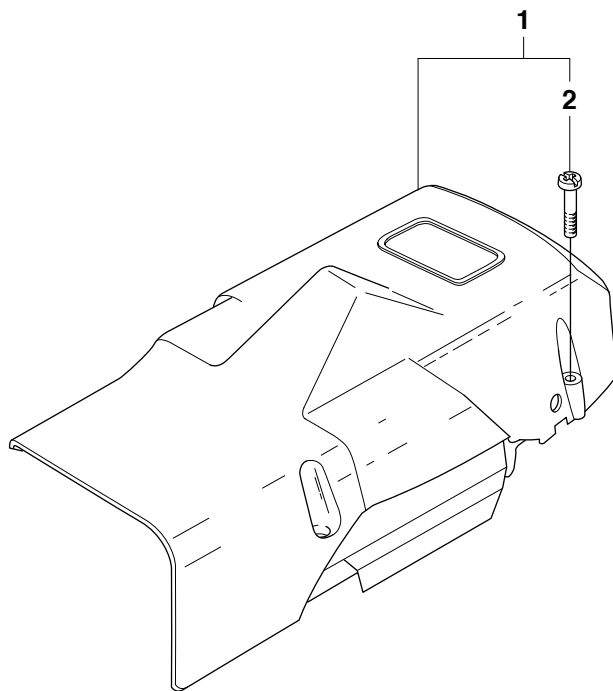

Page C		CS2165		CYLINDER COVER	
Position	Article	Quantity	Notes	Kit	
1	503 69 74-01	1			
2	503 20 34-25	3		1	

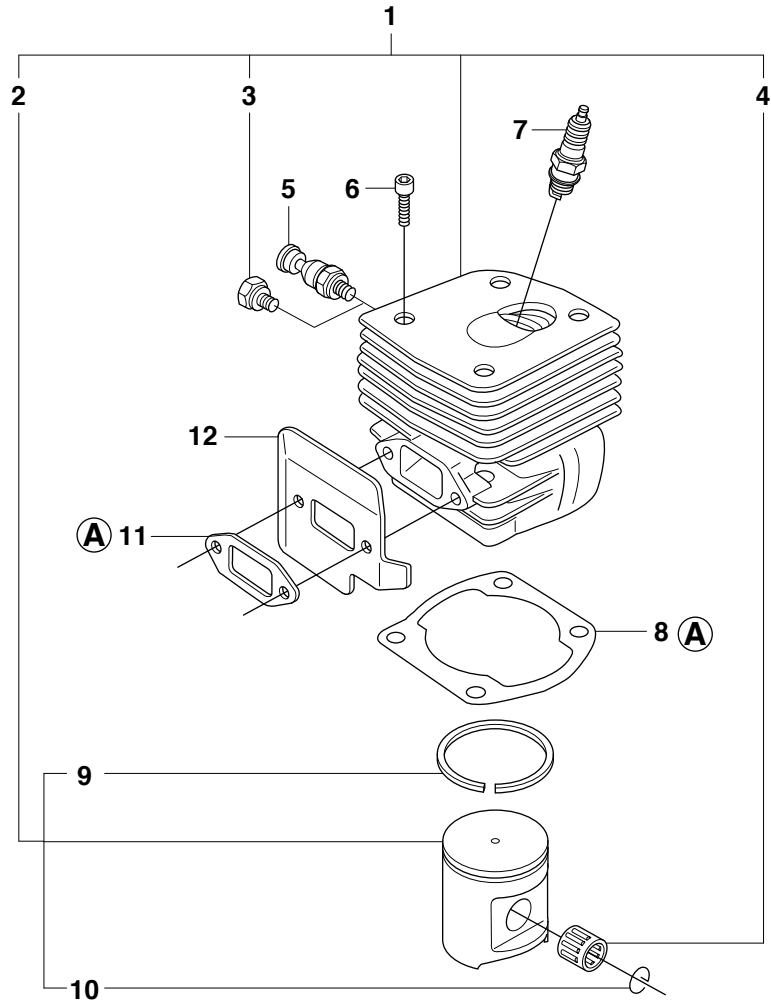
DCS2165
CYLINDER PISTON

13

(A) 503 64 72-01
Set of gaskets

Page D		CS2165		CYLINDER PISTON	
Position	Article	Quantity	Notes	Kit	
1	503 93 90-05	1			
2	503 69 13-03	1		1	
3	503 55 22-01	1		1	
4	503 25 56-01	1		1	
5	503 71 53-01	1			
6	725 53 33-55	4			
7	503 23 51-08	1	RCJ 7Y		
8	503 96 15-01	1		13	
9	503 28 90-15	1		1, 2	
10	737 43 12-00	2		1, 2	
11	503 77 59-01	1		13	
12	503 77 58-02	1			
13	503 64 72-01	1	A = Set of gaskets		

E CS2165
CRANKSHAFT

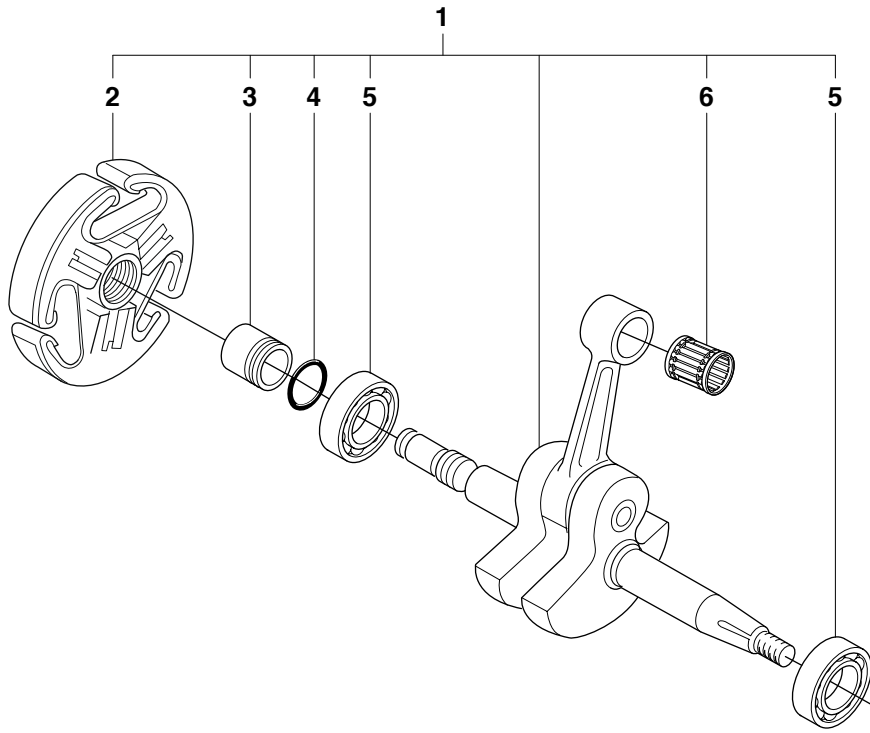

Position	Article	Quantity	Notes	Kit
1	503 74 87-03	1		
2	503 74 44-01	1		1
3	503 77 91-01	1		1
4	503 26 30-19	1		1
5	738 22 02-25	2		1
6	503 25 56-01	1		1

F CS2165
MUFFLER

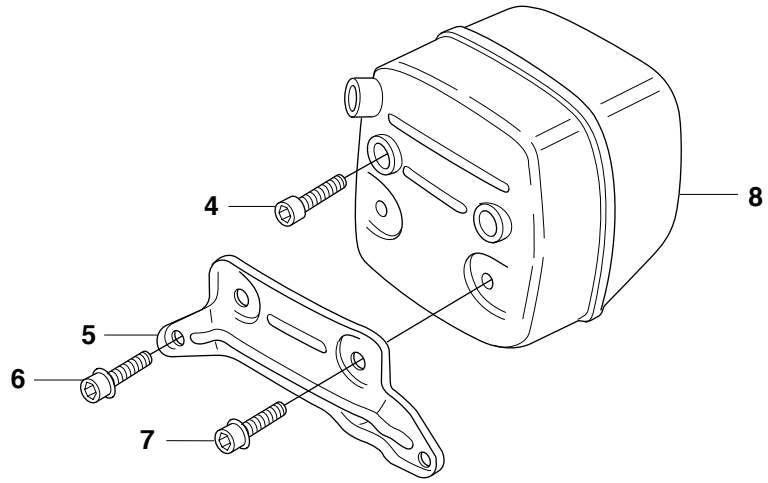
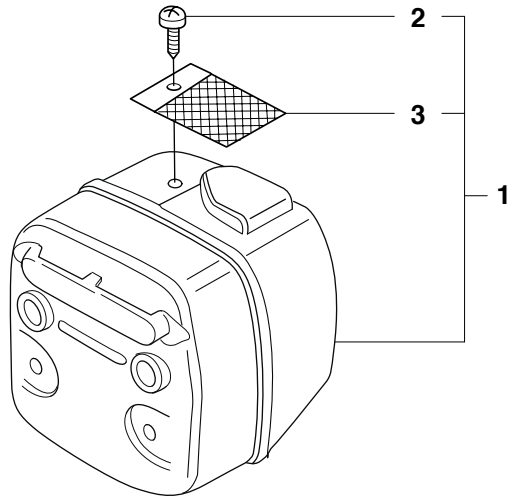

Page F		CS2165		MUFFLER	
Position	Article	Quantity	Notes	Kit	
1	544 02 97-02	1	DF		
2	724 12 87-59	1		1	
3	503 76 64-02	1		1	
4	725 53 70-55	2			
5	503 76 65-03	1			
6	503 20 07-74	2			
7	503 20 07-02	2			
8	544 02 95-01	1	Tube		
8	544 02 95-02	1	Jungle		

G CS2165
CARBURETOR & AIR FILTER

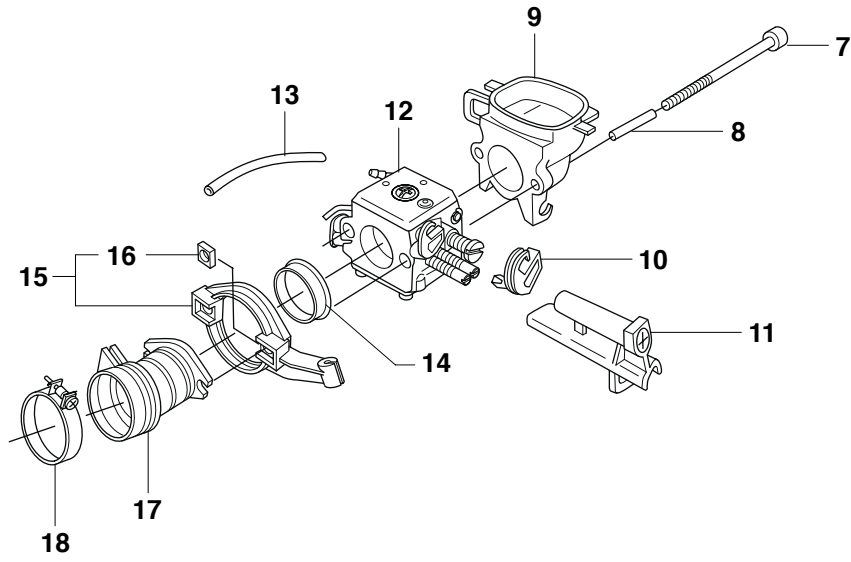
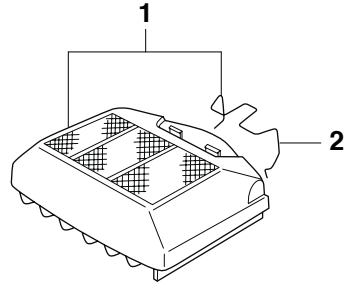

Position	Article	Quantity	Notes	Kit
1	503 82 07-01	1	80 μ	
1	503 82 07-02	1	44 μ	
1	503 82 07-03	1	Felt	
2	503 73 54-01	1		
7	725 53 05-55	2		
8	503 70 11-01	2		
9	503 62 75-01	1		
10	503 68 41-01	1		
11	503 66 53-01	1		
11	503 66 74-01	1	EPA, EU	
12	503 28 18-04	1		
12	503 28 18-05	1	EPA, EU	
13	503 40 06-06	1		
14	503 43 18-01	1		
15	503 71 27-01	1		
16	503 22 65-03	2		15
17	503 96 45-01	1		
18	505 28 33-01	1		

H CS2165
CRANKCASE

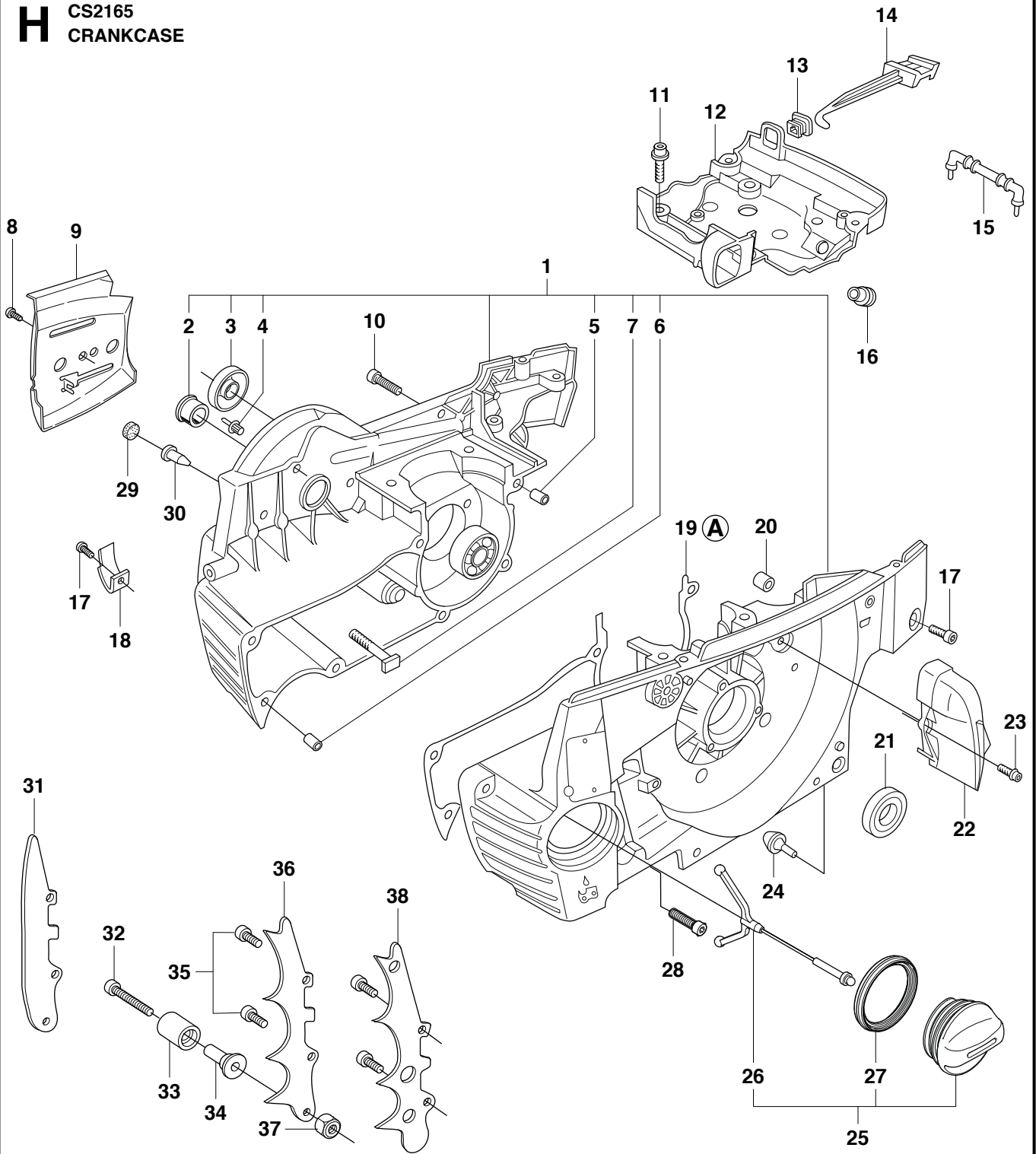

39

A 503 64 72-01
Set of gaskets

Page H		CS2165		CRANKCASE	
Position	Article	Quantity	Notes	Kit	
1	503 62 68-10	1			
2	503 96 70-01	1		1	
3	503 26 03-01	1		1	
4	503 75 18-01	1		1	
5	501 27 08-01	1		1	
6	501 27 08-01	1		1	
7	537 05 13-01	2		1	
8	503 21 28-10	1			
9	537 04 66-01	1			
10	503 74 93-01	1			
11	503 20 02-12	4			
12	503 62 73-04	1			
13	503 73 44-01	1			
14	503 70 51-01	1			
15	503 67 86-01	1			
16	537 09 54-01	1			
17	725 53 31-65	2			
18	501 68 68-01	1			
19	503 62 72-01	1		39	
20	503 85 73-01	1			
21	505 27 57-19	1			
22	503 62 84-01	1			
23	503 20 02-12	1			
24	503 84 61-01	1			
25	537 21 52-01	1			
26	503 57 89-01	1		25	
27	537 21 50-01	1		25	
28	503 20 08-70	6			
29	537 40 35-01	1			
30	530 02 61-19	1			
31	537 04 29-01	1			
32	503 20 07-80	1			
33	537 02 44-01	1			
34	537 08 92-01	1			
35	503 20 02-16	2			
36	537 01 71-01	1			
37	503 22 24-01	1			
38	503 64 79-02	1			
39	503 64 72-01	1	A = Set of gaskets		

J CS2165
FUEL TANK

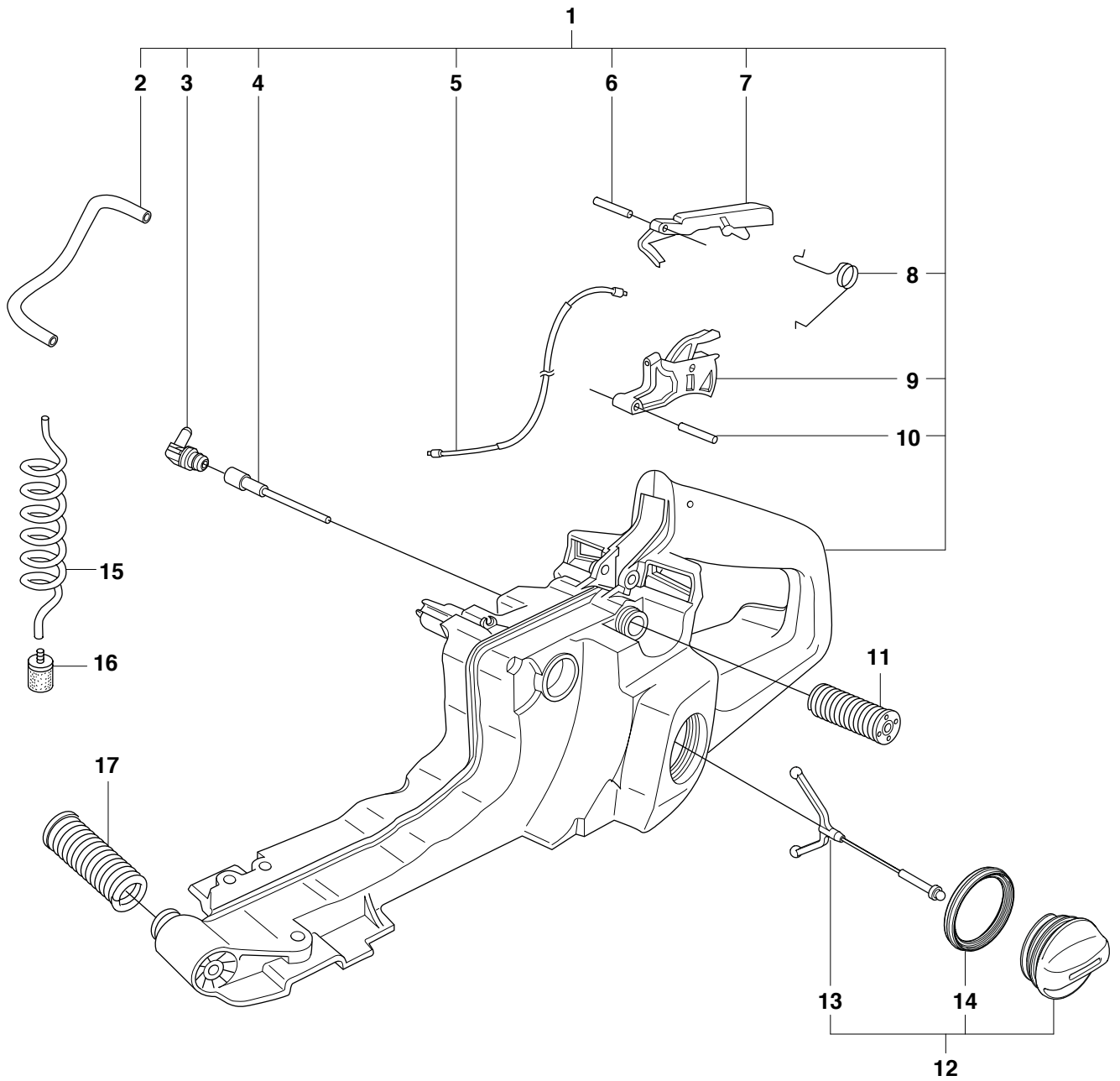

Position	Article	Quantity	Notes	Kit
1	503 71 91-71	1		
2	544 32 49-06	1		1
3	537 09 93-01	1		1
4	537 09 22-01	1		1
5	503 71 76-01	1		1
6	720 12 40-20	1		1
7	503 55 66-02	1		1
8	503 73 64-01	1		1
9	503 82 98-02	1		1
10	720 12 72-20	1		1
11	503 89 56-01	1	Std	
11	503 89 56-02	1	Hard	
12	537 21 52-01	1		
13	503 57 89-01	1		12
14	537 21 50-01	1		12
15	544 32 50-02	1		
16	503 44 32-01	1		
17	503 63 76-01	1	Std	
17	503 63 76-02	1	Hard	

K CS2165
HANDLE

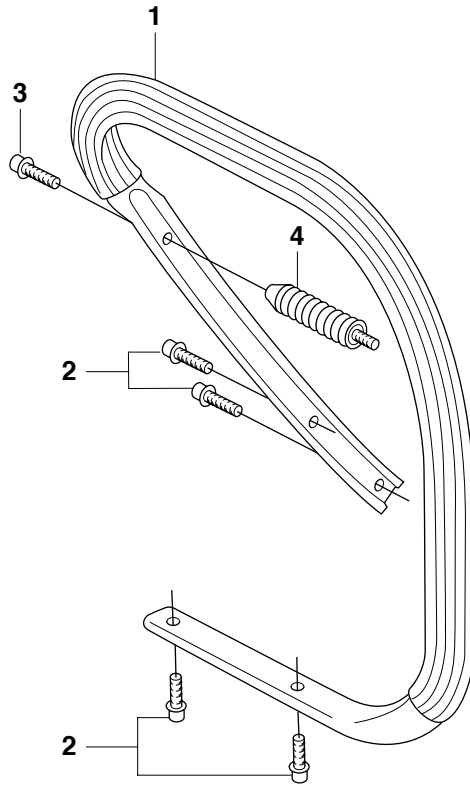

Page K		CS2165		HANDLE	
Position	Article	Quantity	Notes	Kit	
1	503 80 30-01	1			
2	503 21 49-16	4			
3	503 21 05-22	1			
4	503 63 75-02	1	Std		
4	503 63 75-03	1	Hard		

L CS2165
IGNITION SYSTEM

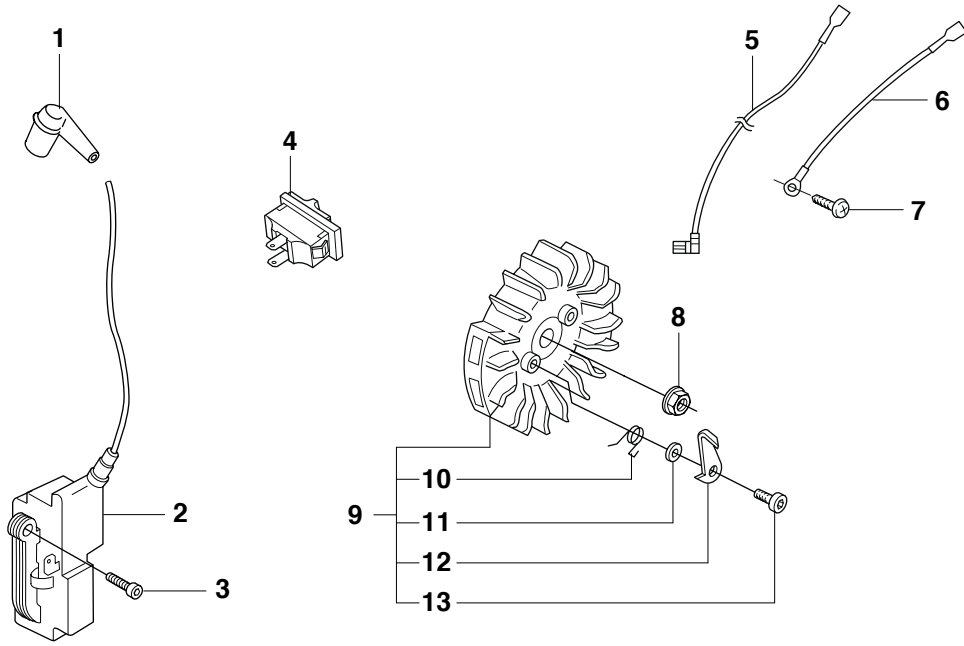

Page L		CS2165		IGNITION SYSTEM	
Position	Article	Quantity	Notes	Kit	
1	501 48 54-02	1			
2	544 04 71-01	1			
2	510 11 57-01	1	COT		
3	503 20 02-20	2			
4	503 71 82-01	1			
5	503 62 61-01	1			
6	503 89 76-01	1			
7	503 21 28-10	1			
8	503 22 04-01	1			
9	537 05 16-05	1			
10	501 67 35-01	2		9	
11	503 23 00-42	2		9	
12	537 01 55-01	2		9	
13	501 81 99-01	2		9	

M CS2165
STARTER

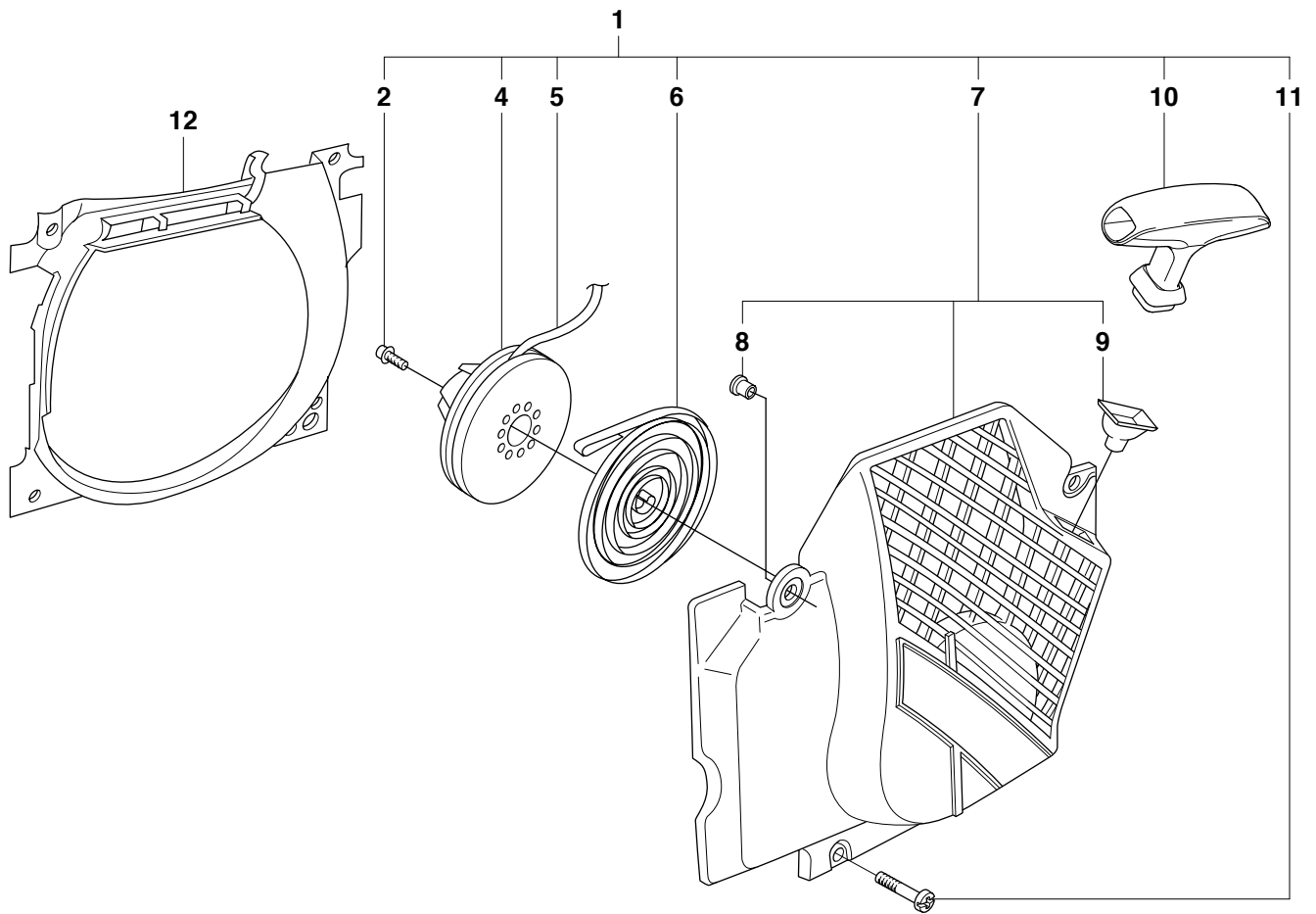

Page M		CS2165		STARTER	
Position	Article	Quantity	Notes	Kit	
1	503 69 28-03	1			
2	503 21 52-16	1		1	
4	503 85 96-01	1		1	
5	503 43 29-02	1		1	
6	503 78 72-01	1		1	
7	503 69 29-04	1		1	
8	537 08 67-01	1		1, 7	
9	501 63 06-01	1		1, 7	
10	537 19 65-01	1		1, 7	
11	544 08 03-01	4		1	
12	503 62 83-01	1			

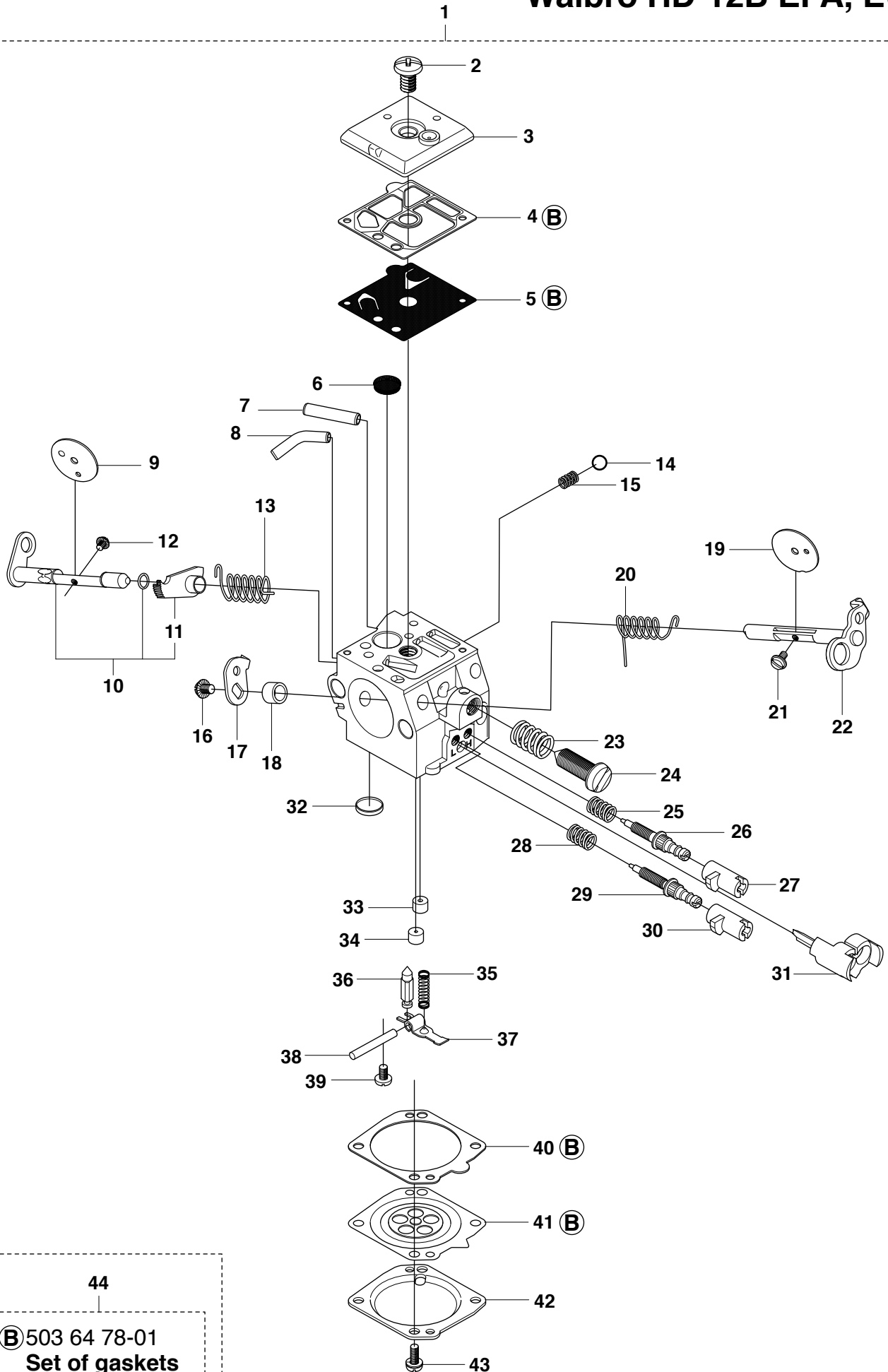

(B) 503 64 78-01
Set of gaskets

Page N		CS2165		CARBURETOR	
Position	Article	Quantity	Notes	Kit	
1	503 28 18-04	1			
1	503 28 18-05	1	EPA, EU		
2	501 46 69-01	1			
3	503 79 98-01	1			
4	501 66 69-01	1		1, 44	
5	502 25 47-01	1		1, 44	
6	501 66 61-01	1			
7	503 85 59-01	1			
8	503 80 14-01	1			
9	503 85 58-01	1			
10	537 01 91-01	1			
11	537 01 89-01	1		1, 10	
12	501 46 87-01	1			
13	537 01 90-01	1			
14	501 46 85-01	1			
15	501 46 84-01	1			
16	501 46 87-01	1			
17	503 79 96-01	1			
18	503 80 15-01	1			
19	503 80 00-01	1			
20	503 80 09-01	1			
21	530 03 50-15	1			
22	503 79 99-01	1			
23	501 66 78-01	1			
24	503 80 08-01	1			
25	501 66 77-01	1			
26	503 80 11-01	1	H		
26	503 94 39-01	1	H EPA, EU		
27	503 91 39-01	1	EPA, EU		
28	501 66 77-01	1			
29	504 02 72-13	1	L		
29	503 94 38-01	1	L EPA, EU		
30	503 91 40-01	1	EPA, EU		
31	503 91 54-01	1	EPA, EU		
32	503 57 42-01	1			
33	503 80 04-01	1			
33	503 94 36-01	1	EPA, EU		
34	503 68 82-01	1			
34	537 00 33-01	1	EPA, EU		
35	503 56 24-01	1			
35	503 94 37-01	1	EPA, EU		
36	503 56 34-01	1			
37	501 66 83-01	1			
38	505 52 01-25	1			
39	505 31 67-17	1			
40	504 13 09-05	1		1, 44	
41	503 80 07-01	1		1, 44	
42	537 07 76-01	1			
43	503 10 87-01	4			
44	503 64 78-01	1	B = Set of gaskets		

P CS2165
ACCESSORIES

1

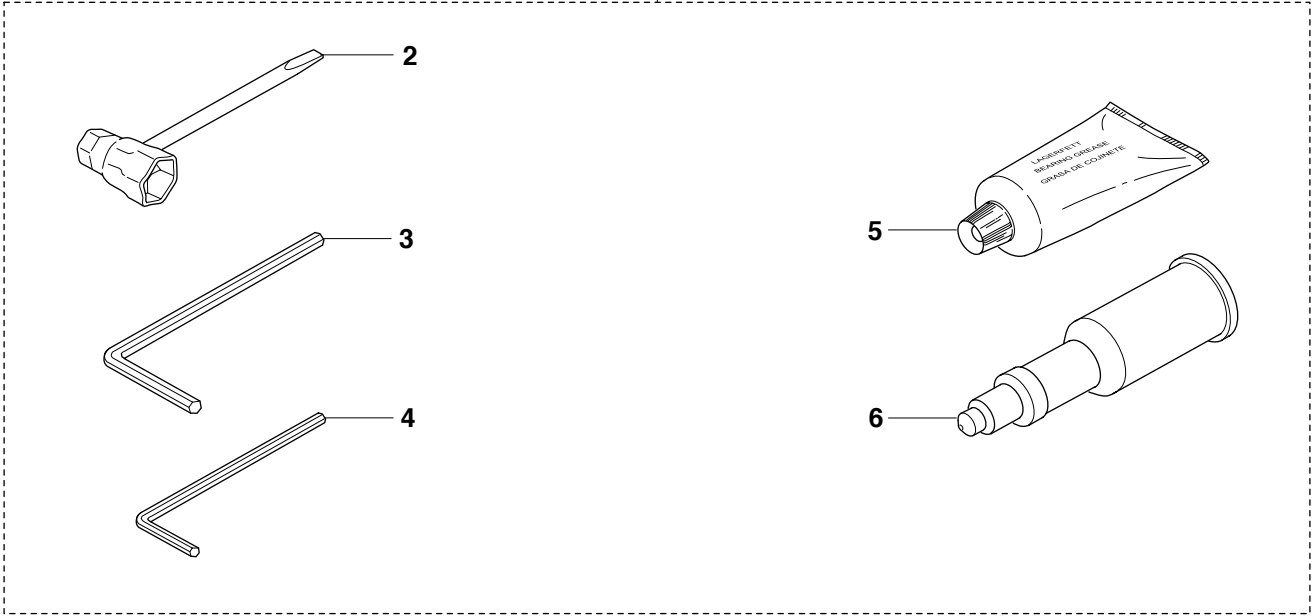

7

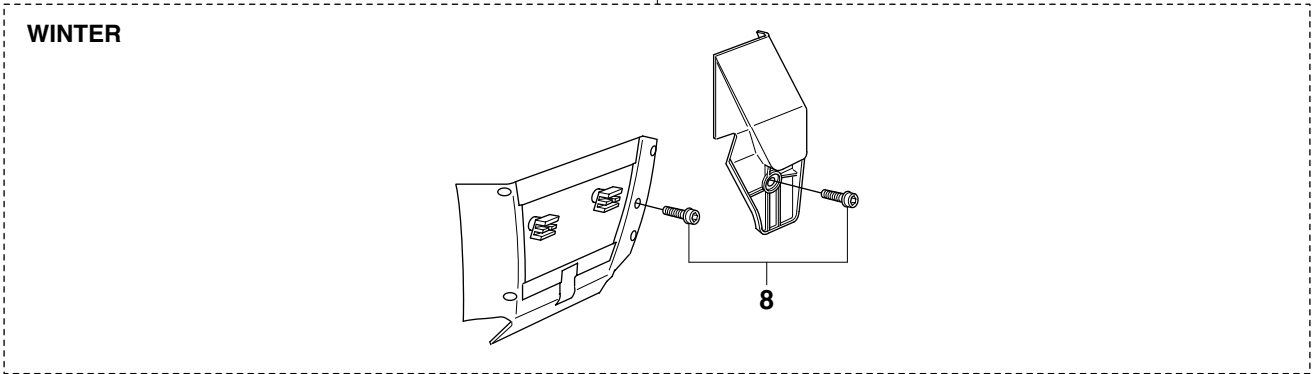

9

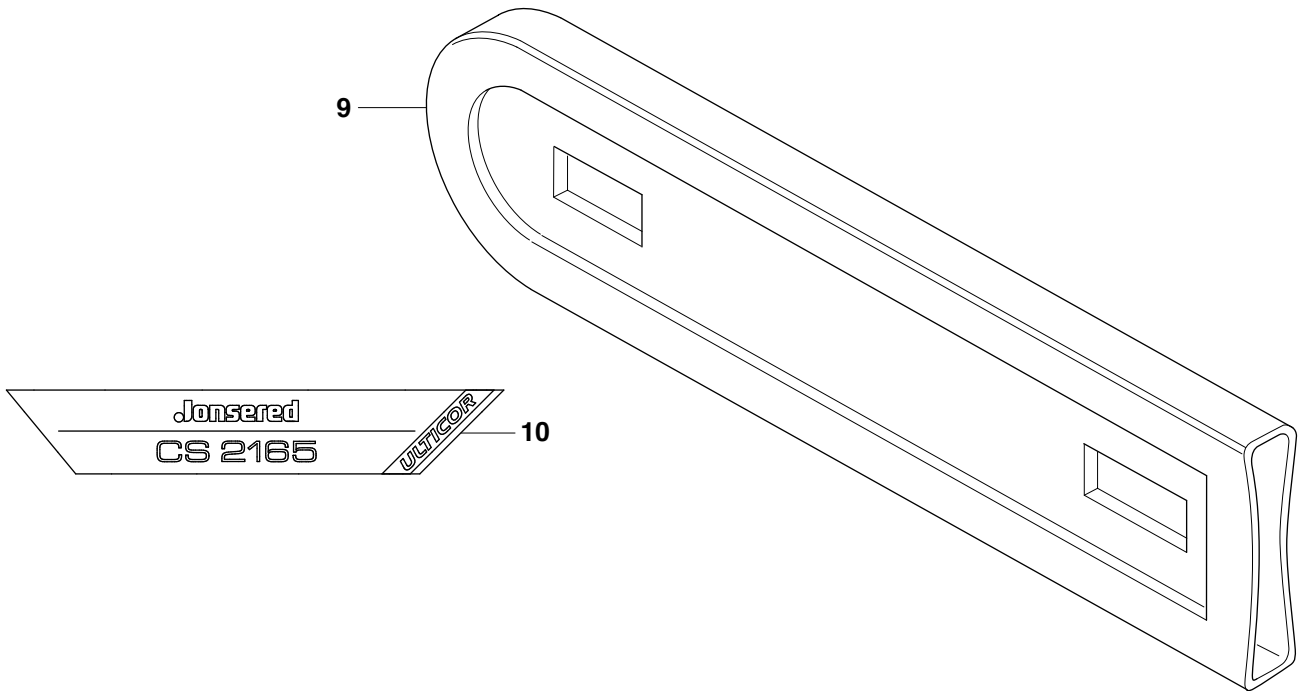

Page P		CS2165		ACCESSORIES	
Position	Article	Quantity	Notes	Kit	
1	503 55 85-01	1			
2	501 69 17-01	1		1	
3	503 55 86-02	1	NV5	1	
4	503 55 86-01	1	NV4	1	
5	503 62 12-01	1		1	
6	501 91 14-01	1		1	
7	503 96 90-10	1	WINTER		
8	503 21 27-16	1		7	
9	501 83 44-02	1	13"-16"	1	
9	501 83 44-05	1	18"-22"	1	
9	501 83 45-02	1	24"-28"	1	
10	537 14 55-08	1		1	

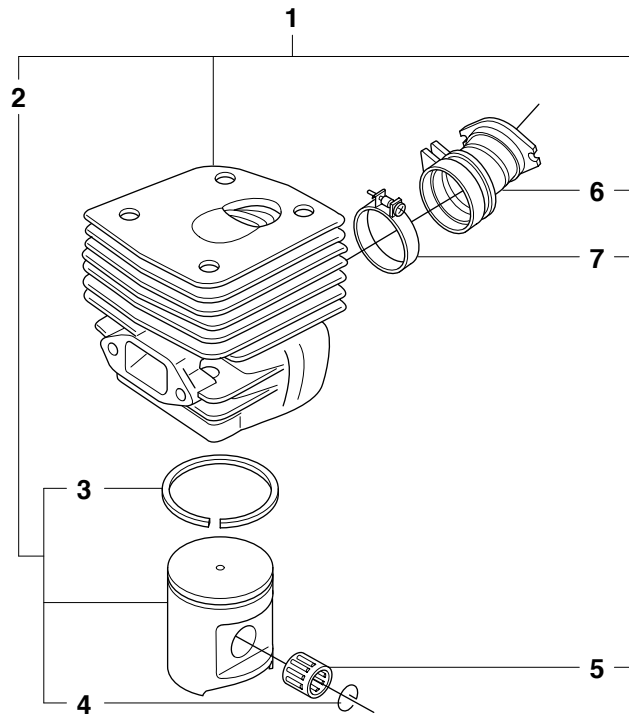

Position	Article	Quantity	Notes	Kit
1	503 93 90-03	1		
2	503 69 13-03	1		1
3	503 28 90-15	1		1, 2
4	737 43 12-00	2		1, 2
5	503 25 56-01	1		1
6	503 96 45-01	1		1
7	505 28 33-01	1		1